

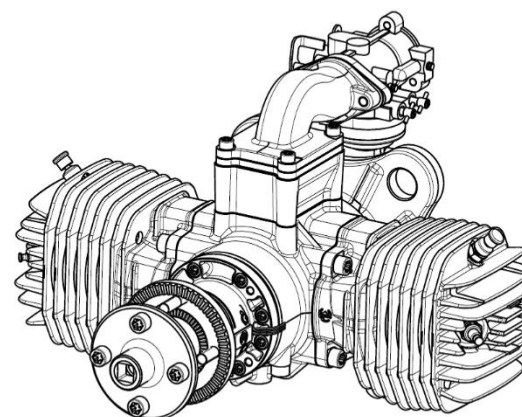

Anlage A
3W-342iB2 TS CS

1. Dreiseitenansicht

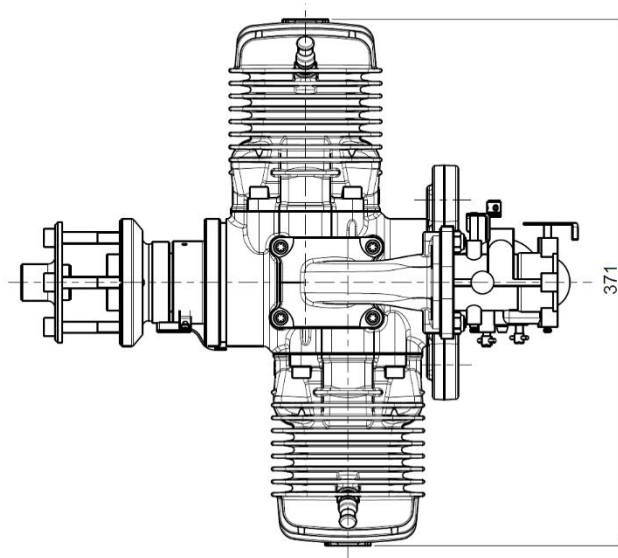
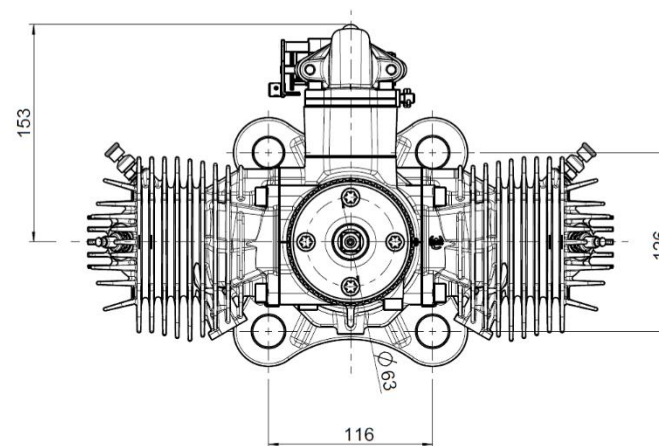
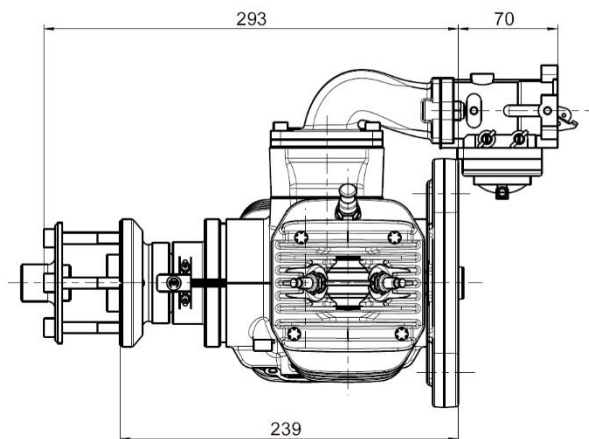

2. Bohrschablone

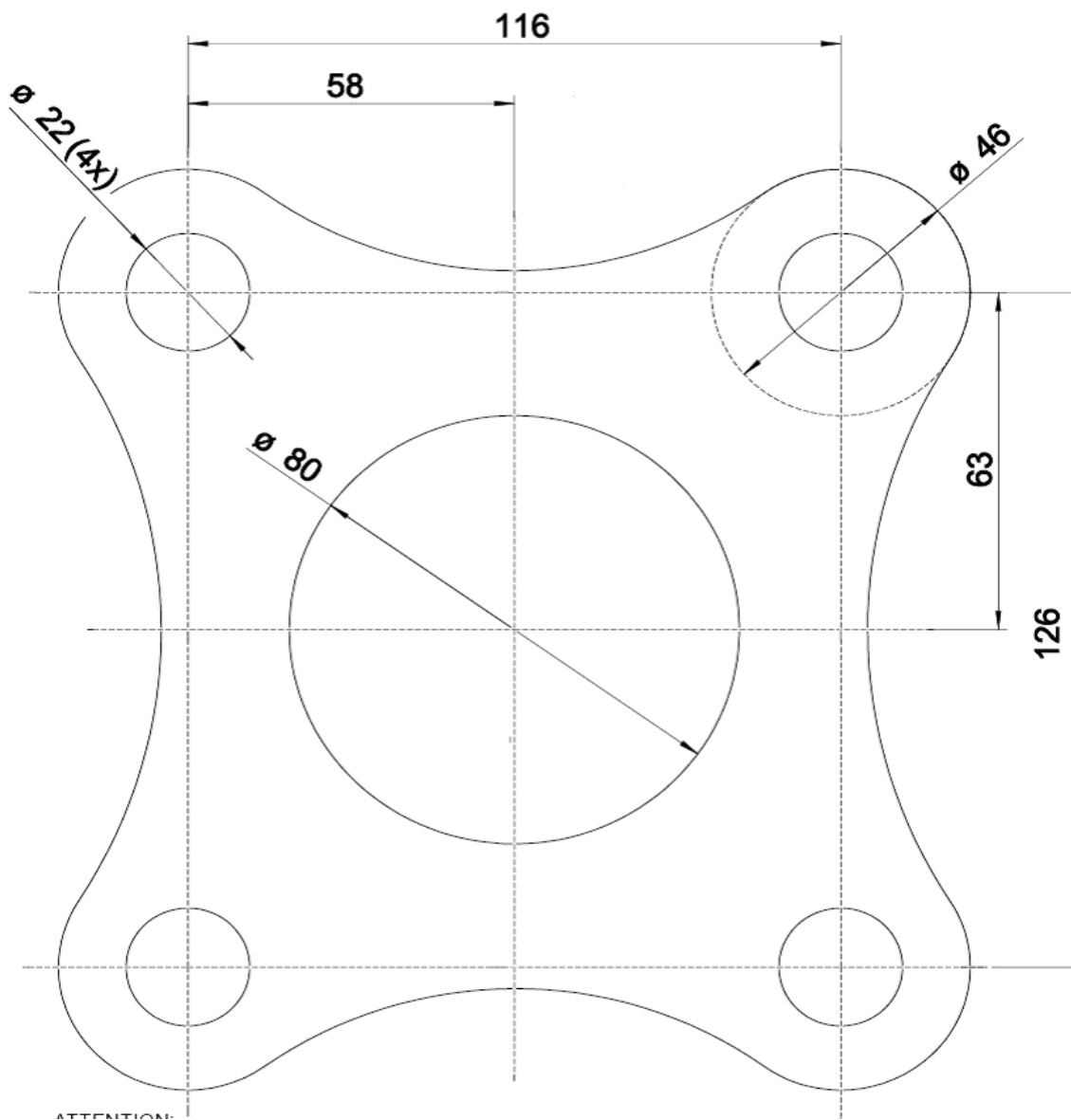



3. Technische Daten

	3W-342iB2 TS CS
Hubraum	342,0 ccm
Leistung	35,8 PS (26,3 KW)
Bohrung	66,00 mm
Hub	50,00 mm
Drehzahlbereich	1.200 – 6.500 U / min
Gewicht inkl. Zündung	8.820 g
Kurbelwelle	3 Kugellager
Pleuel	Nadellager an beiden Enden
Benzingemisch	1 : 50 – 1: 80 (min. 92 Oktan)
IIS – Zündung	6,0 – 8,4 V, 5 Zellen oder 2 Zellen LiPo
2-Blatt Propeller	36 x 14 CFK Bestellnummer 10.101.692 36 x 16 CFK Bestellnummer 10.101.694 39 x 12 CFK Bestellnummer 10.101.696