

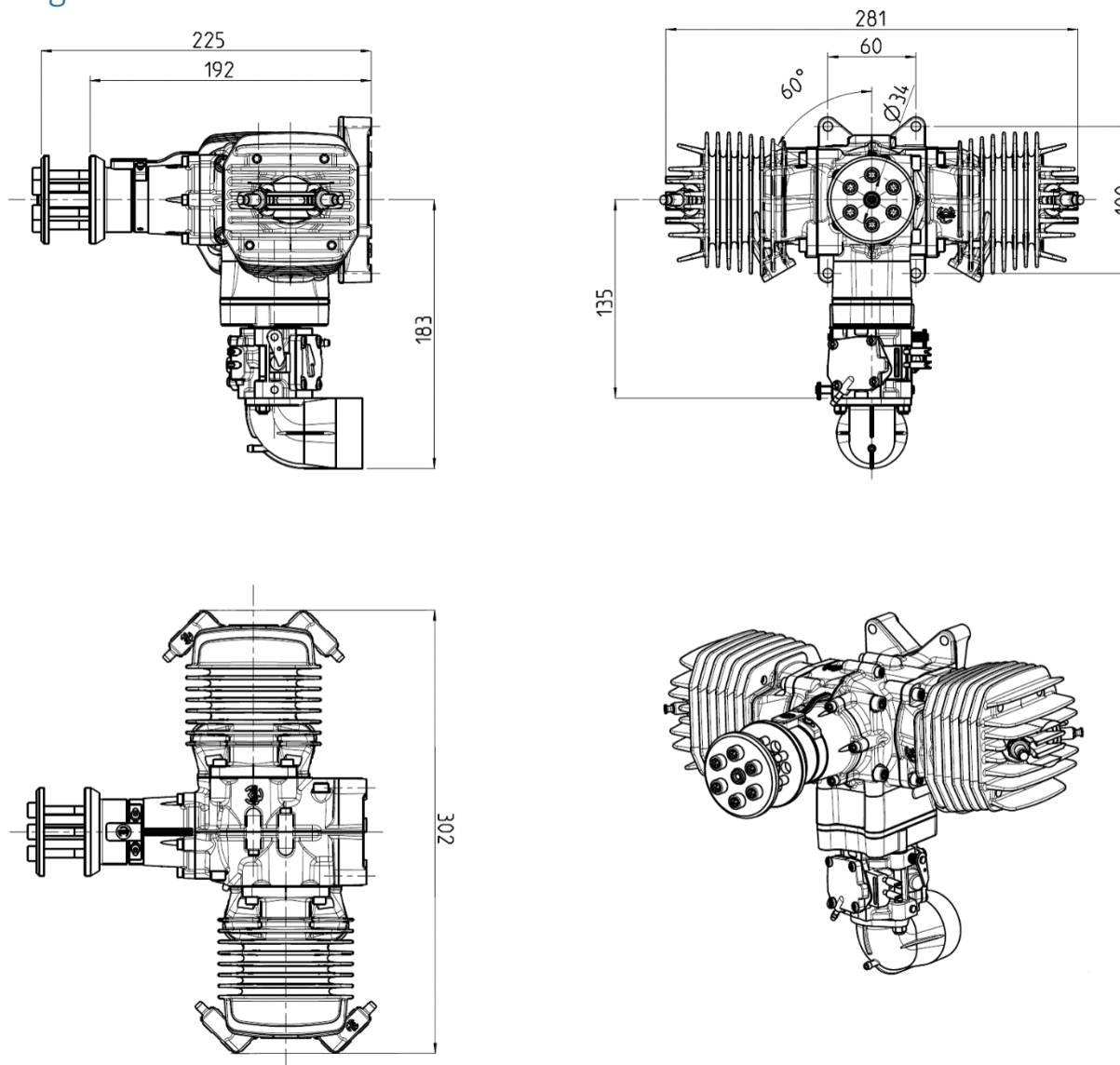

Annex A
3W-157XiB2 TS

1. 3-view drawing



2. Drilling template

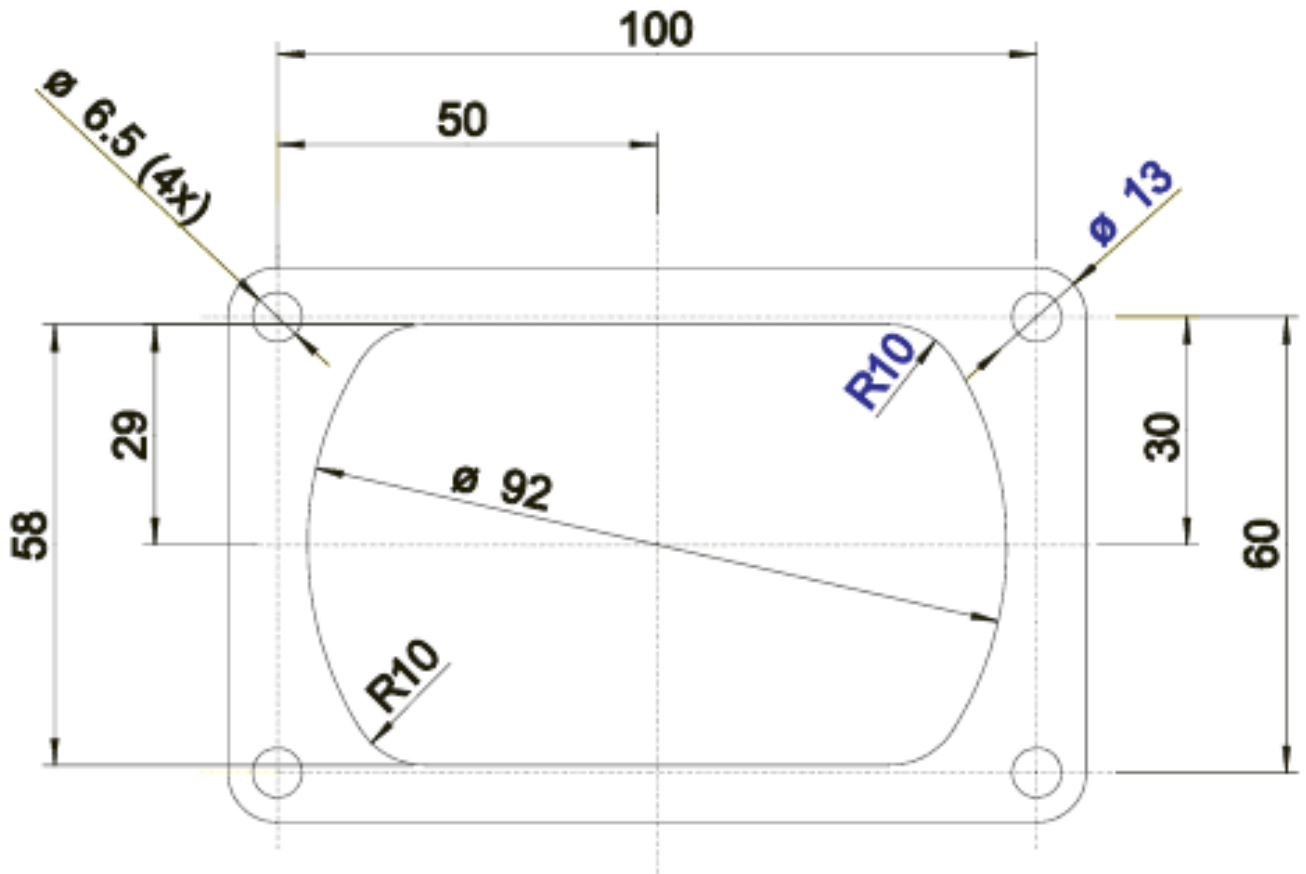



3. Specifications

	3W-157XiB2 TS
Cylinder capacity	157.0ccm
Power	17.5 HP (12.9 KW)
Bore diameter	50.00 mm
Stroke	40.00 mm
Speed range	1,100 – 8,500 rpm
Weight, incl. ignition	4,105 g
Crankshaft	3 ball bearing
Rods	Needle bearings at both ends
Oil / gasoline ratio	1 : 50 – 1: 80 (min. 92 Octan)
IIS – ignition	6.0 – 8.4 V, 5 cells or 2 cells LiPo
2-blade propeller	28 x 12 wood part number 10.101.585 28 x 14 wood part number 10.101.589 30 x 12 wood part number 10.101.597 32 x 10 wood part number 10.101.601 32 x 12 wood part number 10.101.605 31,75 x 14 x 8 CFK part number 10.101.685 (3D)
3-blade propeller	27 x 14 CFK part number 10.101.740 28 x 10 CFK part number 10.101.745