

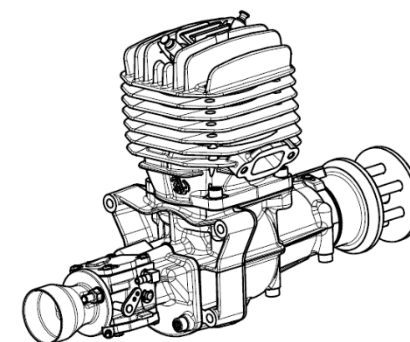

Anlage A
3W-85Xi TS

1. Dreiseitenansicht

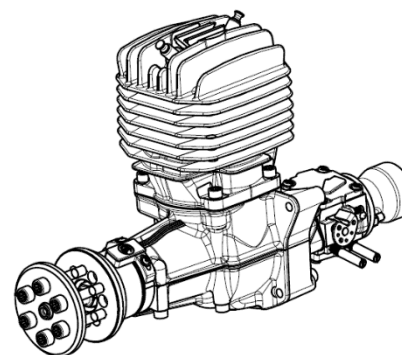
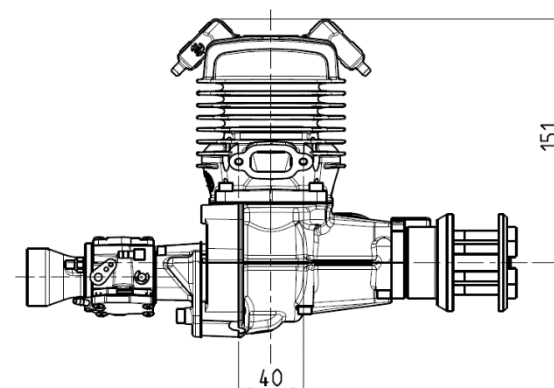
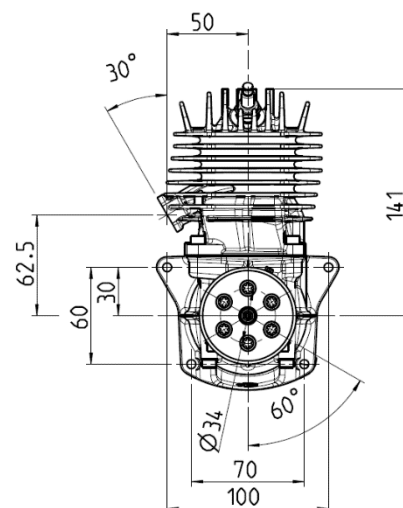
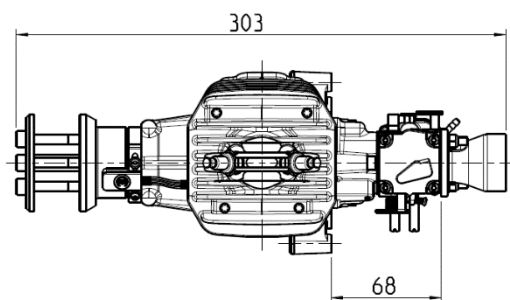
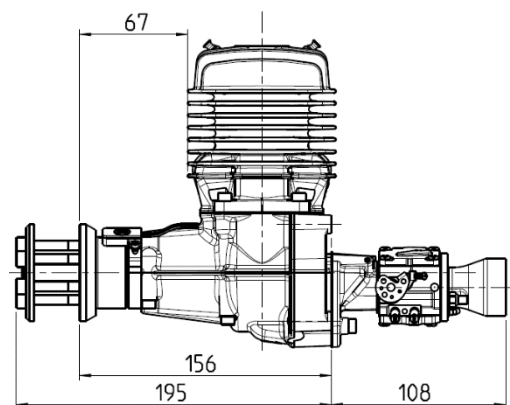
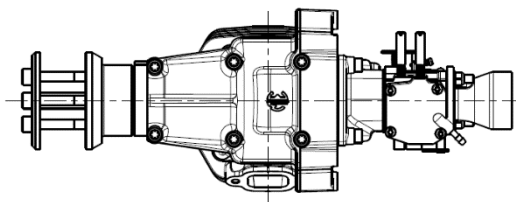

2. Bohrschablone

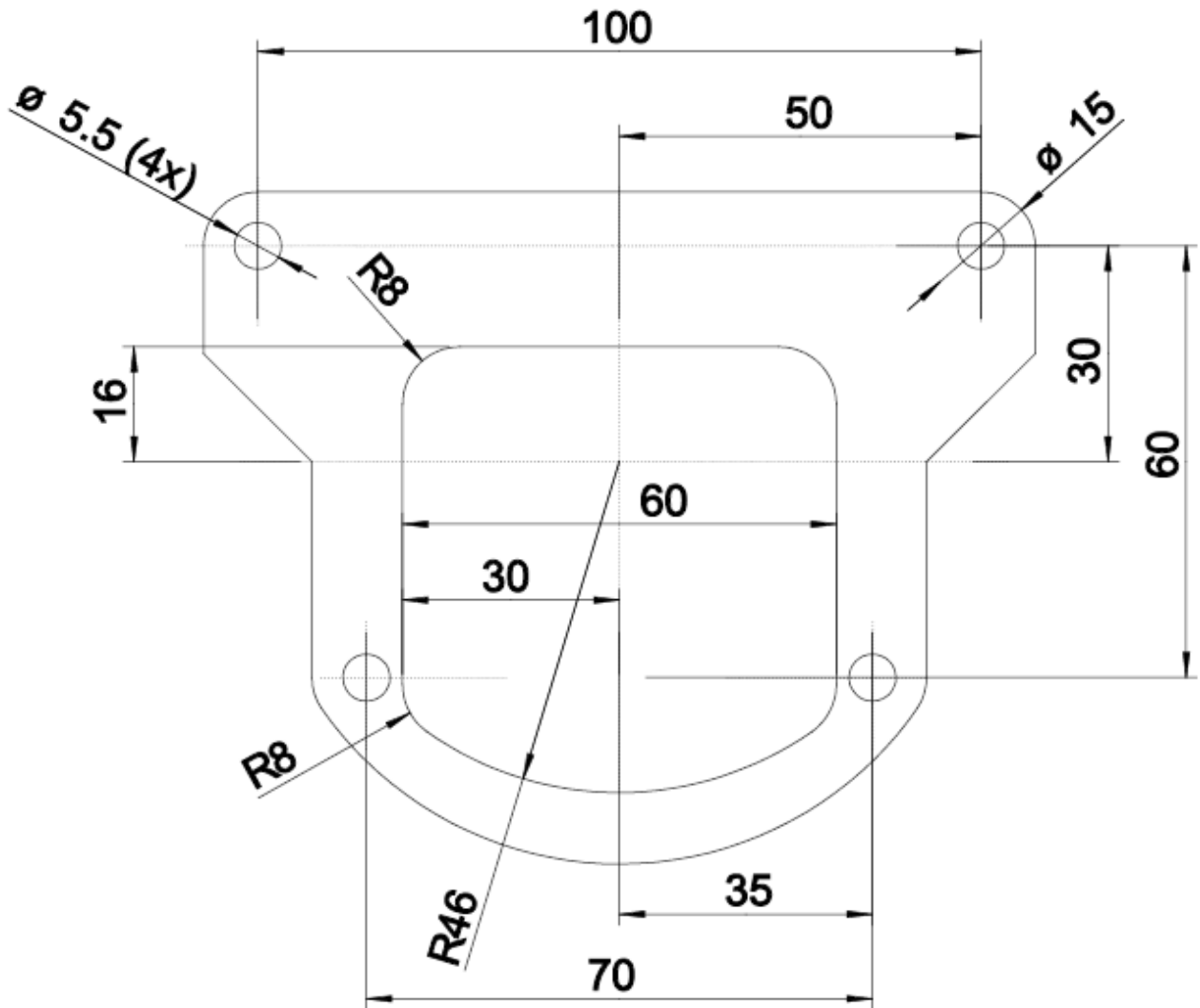



3. Technische Daten

	3W-85Xi TS
Hubraum	83,8 ccm
Leistung	9,4 PS (6,9 KW)
Bohrung	51,00 mm
Hub	41,00 mm
Drehzahlbereich	1.100 – 8.500 U / min
Gewicht inkl. Zündung	2.520 g
Kurbelwelle	3 Kugellager
Pleuel	Nadellager an beiden Enden
Benzingemisch	1 : 50 – 1: 80 (min. 92 Oktan)
IIS – Zündung	6,0 – 8,4 V, 5 Zellen oder 2 Zellen LiPo
2-Blatt Propeller	24 x 12 Holz Bestellnummer 10.101.553 26 x 10 Holz Bestellnummer 10.101.561 26 x 12 Holz Bestellnummer 10.101.565 27 x 10 Holz Bestellnummer 10.101.573 27 x 12 Holz Bestellnummer 10.101.577